

Compatibility Innovation Value

BIO | Trilobe

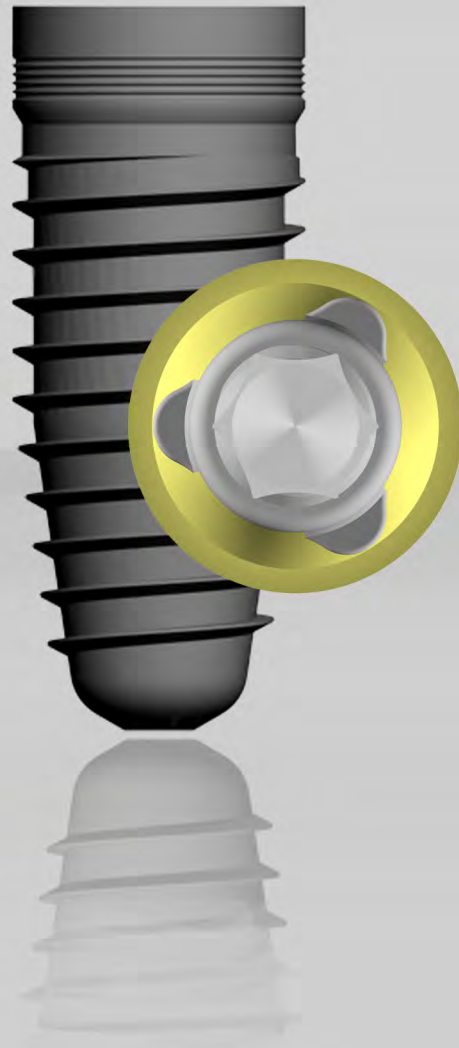

2018

Product Catalog

BIO | Trilobe

January 2018



BlueSkyBio

Table of contents

| | |
|--|-----------------|
| Implant Packs | 2 |
| Practice Building Kits | 2,3 |
| Cover Screws and Healing Abutments | 3,4 |
| Trilobe Conical Abutment | 4 |
| Trilobe KISS Abutments | 5 |
| Trilobe Temporary Abutments | 6 |
| Gold UCLA Abutments (including screw) | 6,7 |
| Multi Unit Abutments | 7,8 |
| Overdenture Abutments | 8,9 |
| Screw Retained Temporary Abutment | 10 |
| Implant Level Analogs | 10 |
| Implant Level Impression Transfers | 10,11 |
| Trilobe Abutment Screw | 11 |
| Surgical Instruments | 11,12,13 |
| X Cube | 13,14 |
| Safety Lateral Sinus Kit | 14 |
| Suture | 14 |
| Master Bone Expander Kit | 14,15 |
| Sinus Lift Kit | 15 |
| Terms & Condition | 16 |



Implant Packs

Packs include Trilobe implant, 1mm cover screw and a 3mm healing abutment.
For easy insertion, implants should be placed with a J-implant insertion driver.
The patented J-implant driver prevents fracture or distortion of implants during insertion. Available only for Blue Sky Bio implants.

3.5mm Implant

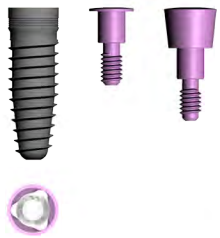

| Size | Part # |
|--------|---------|
| 10mm | ITT3510 |
| 11.5mm | ITT3511 |
| 13mm | ITT3513 |
| 16mm | ITT3516 |

4.3mm Implant

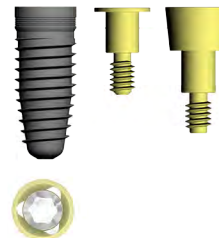

| Size | Part # |
|--------|---------|
| 8mm | ITT4308 |
| 10mm | ITT4310 |
| 11.5mm | ITT4311 |
| 13mm | ITT4313 |
| 16mm | ITT4316 |

5.0mm Implant

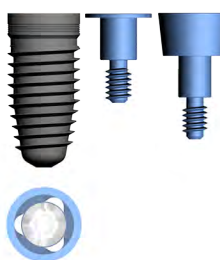

| Size | Part # |
|--------|---------|
| 8mm | ITT5008 |
| 10mm | ITT5010 |
| 11.5mm | ITT5011 |
| 13mm | ITT5013 |
| 16mm | ITT5016 |

6.0mm Implants - 5.0 Platform Switch

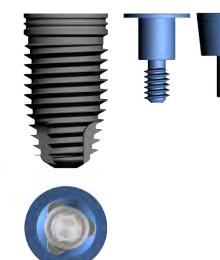

| Size | Part # |
|--------|---------|
| 8mm | ITT6008 |
| 10mm | ITT6010 |
| 11.5mm | ITT6011 |
| 13mm | ITT6013 |
| 16mm | ITT6016 |

Practice Building Kits

Kits include Trilobe implant, 1mm cover screw, 3mm healing abutment, final abutment/implant level impression coping and implant level analog.
For easy insertion, implants should be placed with a J-implant insertion driver.
The patented J-implant driver prevents fracture or distortion of implants during insertion. Available only for Blue Sky Bio implants.

3.5mm Practice Building Kit

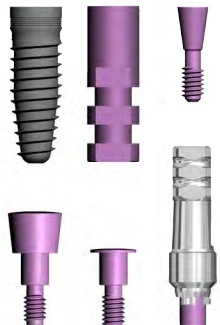

| Size | Part # |
|--------|-------------|
| 10mm | KNPACTA3510 |
| 11.5mm | KNPACTA3511 |
| 13mm | KNPACTA3513 |
| 16mm | KNPACTA3516 |

4.3mm Practice Building Kit

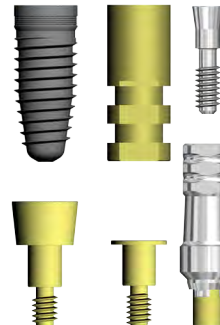

| Size | Part # |
|--------|-------------|
| 8mm | KNPACTA4308 |
| 10mm | KNPACTA4310 |
| 11.5mm | KNPACTA4311 |
| 13mm | KNPACTA4313 |
| 16mm | KNPACTA4316 |

All prices are available in the product section of our website. Volume discounts are available for some items.
Blue Sky Bio is not affiliated with Nobel Biocare. NobelReplace® is a registered trademark of Nobel Biocare.
Blue Sky Bio's products are not manufactured, endorsed, or warranted by Nobel.

5.0mm Practice Building Kit

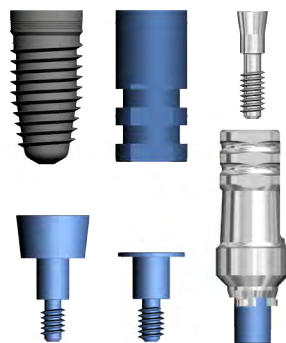

| Size | Part # |
|--------|-------------|
| 8mm | KNPACTA5008 |
| 10mm | KNPACTA5010 |
| 11.5mm | KNPACTA5011 |
| 13mm | KNPACTA5013 |
| 16mm | KNPACTA5016 |

6.0mm Practice Building Kit - 5.0 Platform Switch

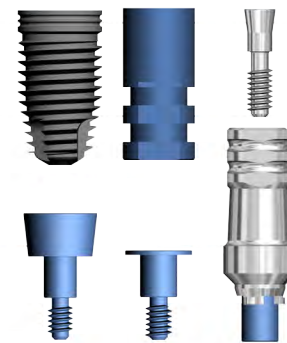

| Size | Part # |
|--------|-------------|
| 8mm | KNPACTA6008 |
| 10mm | KNPACTA6010 |
| 11.5mm | KNPACTA6011 |

Cover Screws and Healing Abutments

Compatible with Blue Sky Bio Trilobe and NobelReplace® implants.
 Cover screws and healing abutments may be placed with a .048 Hex Driver.
 Blue Sky Bio cover screws and healing abutments are compatible with NobelReplace® instrumentation.

| Cover Screws | | |
|---|---------------------------------------|---------|
| | Size | Part # |
|  | 3.5mm x 1mm Cover Screw, 3.5 Platform | CLN3510 |
|  | 4.3mm x 1mm Cover Screw, 4.3 Platform | CLN4310 |
|  | 5.0mm x 1mm Cover Screw, 5.0 Platform | CLN5010 |

| 3mm Healing Abutments | | |
|---|---|----------|
| | Size | Part # |
|  | 3.5mm x 3mm Healing Abutment | HLN3530 |
|  | 4.3mm x 3mm Healing Abutment | HLN4330 |
|  | 5.0mm x 3mm Healing Abutment | HLN5030 |
|  | 6.0mm x 3mm Healing Abutment, 5.0 Platform Switch | HLN5030W |

All prices are available in the product section of our website. Volume discounts are available for some items.
 Blue Sky Bio is not affiliated with Nobel Biocare. NobelReplace® is a registered trademark of Nobel Biocare.
 Blue Sky Bio's products are not manufactured, endorsed, or warranted by Nobel.



| 5mm Healing Abutments | | |
|---|--|----------|
| | Size | Part # |
|  | 3.5mm x 5mm Healing Abutment | HLN3550 |
|  | 4.3mm x 5mm Healing Abutment | HLN4350 |
|  | 5.0mm x 5mm Healing Abutment | HLN5050 |
|  | 6.0mm x 5mm Healing Abutment, 5.0 Platform Switch | HLN5050W |

Trilobe Conical Abutments



Only compatible with Blue Sky Bio Trilobe implants.

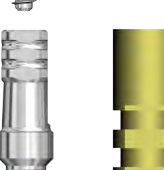
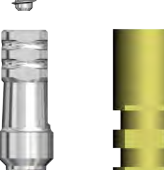

Abutment with included fixation screw is also impression transfer.

Conical Abutment Kits include a Conical abutment, fixation screw and analog kit contains all necessary restorative and laboratory components.

| 3.5 mm Abutments | | |
|--|--------------------------|---------|
| | Size | Part # |
|  | 3.5 Conical Abutment Kit | KAT3570 |
|  | 3.5 Conical Abutment | ATT3570 |
|  | 3.5 Implant Level Analog | BITT35 |

| 4.3 mm Abutments | | |
|--|--------------------------|---------|
| | Size | Part # |
|  | 4.3 Conical Abutment Kit | KAT4370 |
|  | 4.3 Conical Abutment | ATT4370 |
|  | 4.3 Implant Level Analog | BITT43 |

| 5.0 mm Abutments | | |
|--|--------------------------|---------|
| | Size | Part # |
|  | 5.0 Conical Abutment Kit | KAT5070 |
|  | 5.0 Conical Abutment | ATT5070 |
|  | 5.0 Implant Level Analog | BITT50 |

| 5.0 mm Abutments - Wide | | |
|--|--------------------------|----------|
| | Size | Part # |
|  | 5.0 Conical Abutment Kit | KAT5070W |
|  | 5.0 Conical Abutment | ATT5070W |
|  | 5.0 Implant Level Analog | BITT50W |

All prices are available in the product section of our website. Volume discounts are available for some items.

Blue Sky Bio is not affiliated with Nobel Biocare. NobelReplace® is a registered trademark of Nobel Biocare.

Blue Sky Bio's products are not manufactured, endorsed, or warranted by Nobel.

Trilobe KISS Abutments

Only compatible with Blue Sky Bio Trilobe implants.

Complete Kits include KISS abutment, screw, metal analog, two resin analogs, impression coping, engaging and non-engaging waxing sleeves and temporary sleeve.

Impression Kits include two resin analogs, impression coping, engaging and non-engaging waxing sleeves and temporary sleeve.

3.5 Platform KISS 2mm



| Size | Part # |
|--------------------------------------|-----------|
| 3.5 Regular KISS Complete Kit | KASTT3502 |
| 3.5 Regular KISS Abutment 2mm collar | ASTT3502 |
| KISS Abutment Analog, Regular | BMKISR |
| KISS Impression Kit Regular | KIKR |

4.3 Platform KISS 2mm



| Size | Part # |
|--------------------------------------|-----------|
| 4.3 Regular KISS Complete Kit | KASTT4302 |
| 4.3 Regular KISS Abutment 2mm collar | ASTT4302 |
| KISS Abutment Analog, Regular | BMKISR |
| KISS Impression Kit Regular | KIKR |

5.0 Platform KISS 2mm



| Size | Part # |
|-----------------------------------|-----------|
| 5.0 Wide KISS Complete Kit | KASTT5002 |
| 5.0 Wide KISS Abutment 2mm collar | ASTT5002 |
| KISS Abutment Analog, Wide | BMKISW |
| KISS Impression Kit Wide | KIKW |

All prices are available in the product section of our website. Volume discounts are available for some items.

Blue Sky Bio is not affiliated with Nobel Biocare. NobelReplace® is a registered trademark of Nobel Biocare.

Blue Sky Bio's products are not manufactured, endorsed, or warranted by Nobel.

Trilobe Temporary Abutments

Trilobe Temporary Abutments are only compatible with Blue Sky Bio implants.
Trilobe Temporary Abutments are not lobe engaging.

3.5 Temporary Abutment

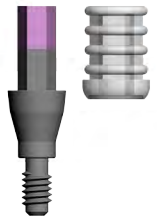

| Size | Part # |
|------------------------|---------|
| 3.5 Temporary Abutment | ATTMP35 |

4.3 Temporary Abutment

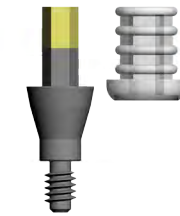

| Size | Part # |
|------------------------|---------|
| 4.3 Temporary Abutment | ATTMP43 |

5.0 Temporary Abutment



| Size | Part # |
|------------------------|---------|
| 5.0 Temporary Abutment | ATTMP50 |

Gold UCLA Abutments (including screw)

UCLA abutments are gold alloy.
UCLA abutment includes screw.
Only compatible with Blue Sky Bio Trilobe implants. Not compatible with Nobel implants.

Gold UCLA 3.5 mm



| Size | Part # |
|---------------------------|-----------|
| 3.5 Gold UCLA Abutment | AUCLAT35G |
| Additional Abutment Screw | SLN18 |

Gold UCLA 4.3 mm







| Size | Part # |
|---------------------------|-----------|
| 4.3 Gold UCLA Abutment | AUCLAT43G |
| Additional Abutment Screw | SLN20 |





All prices are available in the product section of our website. Volume discounts are available for some items.
Blue Sky Bio is not affiliated with Nobel Biocare. NobelReplace® is a registered trademark of Nobel Biocare.
Blue Sky Bio's products are not manufactured, endorsed, or warranted by Nobel.





| Gold UCLA 5.0 mm | |
|---------------------------|-----------|
| Size | Part # |
| 5.0 Gold UCLA Abutment | AUCLAT50G |
| Additional Abutment Screw | SLN20 |











Multi Unit Abutments

| 3.5 Platform | |
|---|-----------|
| Size | Part # |
|  Abutment Multi Unit Straight, 3.5 platform, Trilobe, 1.5mm cuff - Requires .080 Hex Driver | AMUSN3515 |
|  Abutment Multi Unit Straight, 3.5 platform, Trilobe, 3.0mm cuff - Requires .080 Hex Driver | AMUSN3530 |
|  Angled Abutment Multi Unit, 3.5 platform, 17 degree, Trilobe, includes abutment screw | AAMUN3517 |
|  Angled Abutment Multi Unit, 3.5 platform, 30 degree, Trilobe, includes abutment screw | AAMUN3530 |

| 4.3 Platform | |
|---|-----------|
| Size | Part # |
|  Abutment Multi Unit Straight, 4.3 platform, Trilobe, 1.5mm cuff - Requires .080 Hex Driver | AMUSN4315 |
|  Abutment Multi Unit Straight, 4.3 platform, Trilobe, 3.0mm cuff - Requires .080 Hex Driver | AMUSN4330 |
|  Angled Abutment Multi Unit, 4.3 platform, 17 degree, Trilobe, includes abutment screw | AAMUN4317 |
|  Angled Abutment Multi Unit, 4.3 platform, 30 degree, Trilobe, includes abutment screw | AAMUN4330 |

| 5.0 Platform | |
|--|-----------|
| Size | Part # |
|  Abutment Multi Unit Straight, 5.0 platform, Trilobe, 1.5mm cuff - Requires .080 Hex Driver | AMUSN5015 |
|  Abutment Multi Unit Straight, 5.0 platform, Trilobe, 3.0mm cuff - Requires .080 Hex Driver | AMUSN5030 |
|  Angled Abutment Multi Unit, 5.0 platform, 17 degree, Trilobe, includes abutment screw | AAMUN5017 |
|  Angled Abutment Multi Unit, 5.0 platform, 30 degree, Trilobe, includes abutment screw | AAMUN5030 |

All prices are available in the product section of our website. Volume discounts are available for some items. Blue Sky Bio is not affiliated with Nobel Biocare. NobelReplace® is a registered trademark of Nobel Biocare. Blue Sky Bio's products are not manufactured, endorsed, or warranted by Nobel.

| Components | | | | | |
|---|--|--------|---|---|--------|
| Size | | Part # | Size | | Part # |
|  | Comfort Cap for all Multi Unit Abutments | CMU |  | Angled Multi Unit Abutment Delivery Aid | DSMU |
|  | Combination Impression Transfer, Temporary Abutment and Castable Sleeve, Plastic-Requires screw SMUIHS or SMUIHL | MMUP |  | Screw Multi Unit Impression Transfer, long | SMUL |
|  | Combination Impression Transfer/ Temporary Abutment - Titanium Alloy - Requires screw SMUIHS or SMUIHL | MMUT |  | Screw, Multi Unit, Castable Abutments, short | SMUS |
|  | Analog, Multi Unit | BMU |  | .080 Hex Driver for straight Multi Unit Abutments | HFD |

Overdenture Abutments

Master Overdenture Restorative Kit – Chairside includes: overdenture abutment, metal housing, retention inserts, lab processing insert and block out ring

Master Overdenture Restorative Kit – Laboratory includes: overdenture abutment, metal housing, retention inserts, lab processing insert, block out ring, analog and impression transfer



Super Snap Overdenture Restorative Kit – Chairside includes: overdenture abutment, retention inserts and block out ring

Super Snap Overdenture Restorative Kit – Laboratory includes: overdenture abutment, retention inserts, block out ring, analog and impression transfer

For greater flexibility Blue Sky Bio overdenture abutments do not have an internal undercut.

Master Overdenture Restorative Kits 3.5 platform – Chairside Includes Metal Housing

Master Overdenture Restorative Kits 3.5 platform – Laboratory Includes Metal Housing

| Size | Part # |
|--|-----------|
|  Master Overdenture Restorative Kit - Chairside, 3mm | MORKN3530 |
|  Master Overdenture Restorative Kit - Chairside, 5mm | MORKN3550 |

| Size | Part # |
|---|-------------|
|  Master Overdenture Restorative Kit - Laboratory, 3mm | MORKN3530-L |
|  Master Overdenture Restorative Kit - Laboratory, 5mm | MORKN3550-L |

All prices are available in the product section of our website. Volume discounts are available for some items. Blue Sky Bio is not affiliated with Nobel Biocare. NobelReplace® is a registered trademark of Nobel Biocare. Blue Sky Bio's products are not manufactured, endorsed, or warranted by Nobel.

Master Overdenture Restorative Kits 4.3 platform – Chairside Includes Metal Housing

Master Overdenture Restorative Kits 4.3 platform – Laboratory Includes Metal Housing

| Size | Part # |
|--|-----------|
|  Master Overdenture Restorative Kit - Chairside, 3mm | MORKN4330 |

| Size | Part # |
|--|-------------|
|  Master Overdenture Restorative Kit - Laboratory, 3mm | MORKN4330-L |

| | |
|--|-----------|
|  Master Overdenture Restorative Kit - Chairside, 5mm | MORKN4350 |
|--|-----------|

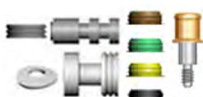
| | |
|--|-------------|
|  Master Overdenture Restorative Kit - Laboratory, 5mm | MORKN4350-L |
|--|-------------|

Master Overdenture Restorative Kits 5.0 platform – Chairside Includes Metal Housing

Master Overdenture Restorative Kits 5.0 platform – Laboratory Includes Metal Housing







| Size | Part # |
|---|-----------|
|  Master Overdenture Restorative Kit - Chairside, 3mm | MORKN5030 |







| Size | Part # |
|---|-------------|
|  Master Overdenture Restorative Kit - Laboratory, 3mm | MORKN5030-L |

| | |
|--|-----------|
|  Master Overdenture Restorative Kit - Chairside, 5mm | MORKN5050 |
|--|-----------|

| | |
|--|-------------|
|  Master Overdenture Restorative Kit - Laboratory, 5mm | MORKN5050-L |
|--|-------------|

Overdenture Products

| Size | Part # |
|---|----------|
|  Complete Flat Snap Restorative Kit | NOPK |
|  Analog | FSA |
|  Replacement Inserts Strong Retention (4 Pack) | FSCS |
|  Replacement Inserts Medium / Light Retention (4 Pack) | FSCR |
|  Resin Impression transfer (2 Pack) and FSCB (4 Pack) | FSI Pack |
|  Ratchet Implant Driver Short | DTSBSIH |

| Size | Part # |
|--|--------|
|  Processing Inserts No Retention (4 Pack) | FSCB |
|  Resin Impression transfer (2 Pack) | FSI |
|  Titanium Housing | HGFS |
|  .050 Hex Driver Short | HTT |
|  .050 Hex Driver Short | SDS050 |
|  Insert Placement/Removal Instrument | TFSU |

All prices are available in the product section of our website. Volume discounts are available for some items. Blue Sky Bio is not affiliated with Nobel Biocare. NobelReplace® is a registered trademark of Nobel Biocare. Blue Sky Bio's products are not manufactured, endorsed, or warranted by Nobel.

Screw Retained Temporary Abutment

Includes abutment screw

Base abutments can be used to bond zirconia custom abutment cylinders, angled or straight up to 15° in angulation.

3.5 Platform Abutment



| Size | Part # |
|--------------------------------|-----------|
| Ti-base for temporary abutment | AUCLAT35G |
| Additional Abutment Screw | SLN18 |

4.3 Platform Abutment



| Size | Part # |
|--------------------------------|-----------|
| Ti-base for temporary abutment | AUCLAT43G |
| Additional Abutment Screw | SLN20 |

Implant Level Analogs

Zirconia Bases



| Size | Part # |
|--------------------------|--------|
| 3.5 Implant Level Analog | BITT35 |
| 4.3 Implant Level Analog | BITT43 |
| 5.0 Implant Level Analog | BITT50 |

Implant Level Impression Transfers

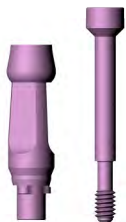

| Size | Part # |
|-------------------------------------|--------|
| 3.5 Closed Tray Impression Transfer | MTT35 |

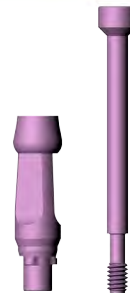

| Size | Part # |
|-----------------------------------|----------|
| 3.5 Open Tray Impression Transfer | MTT35-OT |

All prices are available in the product section of our website. Volume discounts are available for some items. Blue Sky Bio is not affiliated with Nobel Biocare. NobelReplace® is a registered trademark of Nobel Biocare. Blue Sky Bio's products are not manufactured, endorsed, or warranted by Nobel.

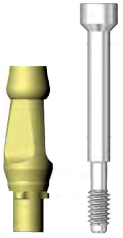

| Size | Part # |
|-------------------------------------|--------|
| 4.3 Closed Tray Impression Transfer | MTT43 |



| Size | Part # |
|-----------------------------------|----------|
| 4.3 Open Tray Impression Transfer | MTT43-OT |

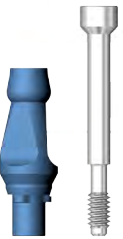



| Size | Part # |
|-------------------------------------|--------|
| 5.0 Closed Tray Impression Transfer | MTT50 |





| Size | Part # |
|-----------------------------------|----------|
| 5.0 Open Tray Impression Transfer | MTT50-OT |

Trilobe Abutment Screw

Only compatible with Blue Sky Bio Trilobe abutments.

| Trilobe Abutment Screw | | |
|---|--------------------------------|--------|
| | Size | Part # |
|  | 3.5mm Abutment Screw | SLN18 |
|  | 4.3mm and 5.0mm Abutment Screw | SLN20 |

Surgical Instruments



| Surgical Instruments | | |
|---|------------------------|--------|
| | Size | Part # |
|  | Adapter for NB Ratchet | NA |
|  | Ratchet Driver | RWA |
|  | .048 Hex Driver | SDS048 |

All prices are available in the product section of our website. Volume discounts are available for some items. Blue Sky Bio is not affiliated with Nobel Biocare. NobelReplace® is a registered trademark of Nobel Biocare. Blue Sky Bio's products are not manufactured, endorsed, or warranted by Nobel.



| Surgical Instruments | | |
|---|--|-----------|
| | Size | Part # |
|  | .048 Hex Driver | SDL048 |
|  | 3.5mm J-Implant Insertion Driver short | DJT35S |
|  | 3.5mm J-Implant Insertion Driver long | DJT35L |
|  | 4.3mm J-Implant Insertion Driver short | DJT43S |
|  | 4.3mm J-Implant Insertion Driver long | DJT43L |
|  | 5.0mm J-Implant Insertion Driver short | DJT50S |
|  | 5.0mm J-Implant Insertion Driver long | DJT50L |
|  | Starter Drill Short | DRILLNSS |
|  | Starter Drill Long | DRILLNSL |
|  | Drill 2.2mm Short | DRILLN22S |
|  | Drill 2.2mm Long | DRILLN22L |
|  | Implant Drill Short 3.5mm | DRILLN35S |
|  | Implant Drill Long 3.5mm | DRILLN35L |
|  | Profile Drill 3.5mm | DRILLP35 |
|  | Implant Drill Short 4.3mm | DRILLN43S |
|  | Implant Drill Long 4.3mm | DRILLN43L |
|  | Profile Drill 4.3mm | DRILLP43 |
|  | Implant Drill Short 5.0mm | DRILLN50S |
|  | Implant Drill Long 5.0mm | DRILLN50L |
|  | Profile Drill 5.0mm | DRILLP50 |
|  | Implant Drill Short 6.0mm | DRILLN60S |

All prices are available in the product section of our website. Volume discounts are available for some items. Blue Sky Bio is not affiliated with Nobel Biocare. NobelReplace® is a registered trademark of Nobel Biocare. Blue Sky Bio's products are not manufactured, endorsed, or warranted by Nobel.

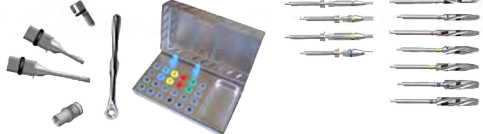





Surgical Instruments

| Size | Part # |
|--|----------|
|  Profile Drill 6.0mm | DRILLP60 |
|  Latch to Square Driver Converter | LS |
|  Trilobe Instrument Box | TIB |
|  Trilobe Complete Surgical Kit | TCSK |

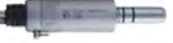

Other Surgical Instrumentation

| Size | Part # |
|---|-----------|
|  Lindemann Bur | LINDR-S21 |
|  Paralleling Pin | GPST22 |

X Cube

| Size | Part # | Size | Part # |
|---|----------|---|------------|
|  Complete Implantology System including 20:1 Handpiece (max speed 2500 RPM) | X Cube |  Complete Implantology and Oral Surgery System including 1:1 Straight Handpiece and 20:1 Handpiece | X Cube IOS |
|  Motor | F100aEI |  1:1 Straight Handpiece External Irrigation | AT-11 |
|  Back Up Implant Air Motor | SCH05-M4 |  Nozzle Clip 1:1 Straight Handpiece, Internal Irrigation | ST-Nozzle |

All prices are available in the product section of our website. Volume discounts are available for some items. Blue Sky Bio is not affiliated with Nobel Biocare. NobelReplace® is a registered trademark of Nobel Biocare. Blue Sky Bio's products are not manufactured, endorsed, or warranted by Nobel.

| Size | Part # |
|---|------------|
|  32:1 Handpiece External Irrigation | ACL(B)-451 |
|  20:1 Handpiece External Irrigation | ACL(B)-411 |
|  16:1 Handpiece External Irrigation | ACL(B)-421 |

| Size | Part # |
|--|-----------|
| Nozzle Clip 16:1, 20:1, 32:1 Handpiece, Internal Irrigation | AG-Nozzle |
| Y-Connector | Y-Conn |
|  Irrigation Tubing | Tube |



Safety Lateral Sinus Kit

| Safety Lateral Sinus Kit | |
|--|--------|
| Size | Part # |
|  Safety Lateral Sinus Kit | SLSK |

Sutures

All sutures are 60cm in length with reverse cutting needles and packaged 12 per box. Sutures sales are currently limited to U.S. customers.

| Size | Part # |
|--|----------|
| PGA Fast Resorb 4-0, FS-2 needle, 12/box | PGF40FS2 |
| PGA 4-0 violet, FS-2 needle, 12/box | PG40FS2 |
| Polypropylene (unbraided black) 5-0, P3 needle, 12/box | P50P3 |

| Size | Part # |
|--|--------|
|  Nylon (unbraided black) 5-0, P3 needle, 12/box | N50P3 |
|  Silk 3-0, FS-2 needle, 12/box | S30FS2 |

Master Bone Expander Kit

Master Bone Expander Kit includes the Bone Expander Kit and four Lerner Ridge Splitting Chisels.

| Master Bone Expander Kit | |
|--|--------|
| Size | Part # |
|  Master Bone Expander Kit | MBEK |

| Bone Expander Kit | |
|--|--------|
| Size | Part # |
|  Bone Expander Kit | BEK |

All prices are available in the product section of our website. Volume discounts are available for some items. Blue Sky Bio is not affiliated with Nobel Biocare. NobelReplace® is a registered trademark of Nobel Biocare. Blue Sky Bio's products are not manufactured, endorsed, or warranted by Nobel.

| Lerner Ridge Splitting Chisels | | |
|--------------------------------------|--------|---|
| Size | Part # | |
| 3mm Chisel with 2mm blade thickness | RSC32 |  |
| 3mm Chisel with .5mm blade thickness | RSC35 | |
| 6mm Chisel with 2mm blade thickness | RSC62 | |
| 6mm Chisel with .5mm blade thickness | RSC65 | |

Sinus Lift Kit

Complete Sinus Lift Kit includes: Sinus Probe, Bone Carrier, Bone Condenser, 2mm Sinus Drill, Sinus Reamers (2.4mm, 2.8mm, 3.2mm, 3.6mm), Stoppers (2mm – 11mm), Stopper Stands, and instrument box.

| Sinus Lift Kit | | |
|--|-----------|--|
| Size | Part # | |
| Hammerless Atraumatic Crestal Sinus Lift Kit | Sinus Kit |  |

All prices are available in the product section of our website. Volume discounts are available for some items. Blue Sky Bio is not affiliated with Nobel Biocare. NobelReplace® is a registered trademark of Nobel Biocare. Blue Sky Bio's products are not manufactured, endorsed, or warranted by Nobel.

Terms & Conditions – Important User Information

Blue Sky Bio, LLC - TERMS AND CONDITIONS – Important User Information

Blue Sky Bio offers high quality dental implant products at much lower prices, compared to its competitors. To help keep our overhead low and prices value-minded, we only accept returns or exchanges under *very limited circumstances*.

RETURNS & EXCHANGES

Blue Sky Bio will accept returns or exchanges within 30 days of original sales receipt. Products returned or exchanged between 31 and 120 days of original sales receipt are subject to a 15% restocking fee. No products can be returned or exchanged after 120 days from date of original sales receipt. Prior to return or exchange please contact us for a Return Authorization Number (RA#). All returned or exchanged products are subject to inspection. Products that have been opened, damaged or marked upon are not eligible for return or exchange. When your products arrive, inspect the packaging and the contents for damage and defects. You must notify us within 7 days from date of original sales receipt if, product packaging is damaged, illegible, or has a broken safety seal; or if product itself appears to be damaged or does not function as its intended use. In these cases, Blue Sky Bio will pay return shipping charges, and will pay shipping charges of replacement products. Blue Sky Bio does not offer a credit or reimburse for implants that do not integrate.

ORDER PLACEMENT

Blue Sky Bio accepts payment for purchases with Visa, MasterCard, and American Express, through its secure website or in limited circumstances, with our fax order form. Prices for products, sales tax, shipping, or any other charges will be listed on your sales receipt. Full payment is due before orders are shipped. Sales are final after shipment has left our distribution center. Blue Sky Bio reserves the right to hold orders until credit card information can be confirmed. You may be contacted by a Blue Sky Bio representative regarding your purchase.

SHIPPING

Orders placed within the United States are shipped via UPS. Orders placed outside the United States are shipped via Fedex. Customers are ultimately responsible to ensure that carriers will deliver at the requested time in their areas. Orders placed before 11am CST will ship the same day. Orders placed after 11am CST may not ship until the next business day. Blue Sky Bio recognizes holidays throughout the year. Watch our home page for notices regarding company closings due to holidays, as this will affect shipping delivery dates.

INTERNATIONAL BROKER / TAX TERMS

Blue Sky Bio utilizes Fedex Express (FE) to ship and broker all orders from the United States to your door. As broker, FE pays all taxes, tariffs, and VAT due on shipments. FE will bill you separately for these charges after you receive your order, including their broker fee. Taxes and broker fees are not part of your shipping charge collected at time of order. By placing your order you authorize Blue Sky Bio to collect any taxes not paid, as soon as reported by FE of tax delinquency, via your credit card on file. You will be responsible for any additional charges or late fees associated with not paying responsible taxes, tariffs, and VAT promptly.

CONTACTING BLUE SKY BIO

Contacting us is very easy and convenient. Call us toll-free 9am – 5pm CST at, **888-446-6724**, or email us anytime at, info@blueskybio.com.

IMPORTANT PRODUCT NOTICES FOR BLUE SKY BIO CUSTOMERS

Blue Sky Bio Two Stage Trilobe implants are compatible with NobelReplace® prosthetics and instrumentation. Blue Sky Bio implants have a patented driver system that prevents fracture during insertion. The driver system is compatible only with Blue Sky Bio implants and cannot be used with any other systems. Only use Blue Sky Bio smooth tapered drills.

Blue Sky Bio's advanced Trilobe conical connection abutments are to be used only with Blue Sky Bio implants.

With the exceptions listed above no other companies products should be used with our system.

Federal Law restricts these devices to sale by or on order of a licensed dentist or physician.

Blue Sky Bio is not affiliated with Nobel Biocare. NobelReplace® is a registered trademark of Nobel Biocare.

Blue Sky Bio tri-lobe implants and abutments are sold subject to a conditional license under U.S. Patent No. 6,733,291 and U.S. Patent No. 5,795,160. Purchasers of Blue Sky Bio tri-lobe implants and abutments agree that the conditional license does not extend to the use of such products in conjunction with products not manufactured by, or on behalf of, Blue Sky Bio or Nobel Biocare.

